

User Guide for MicaSense Sensors

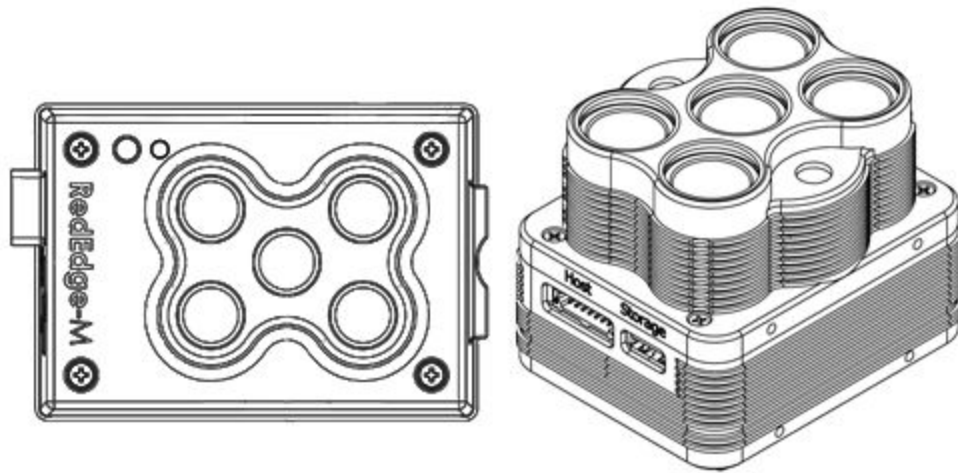

Revision 07, June 2019

MicaSense[®]

Seattle, WA

For Sales & Service Contact



2650 E. 40th Ave. • Denver, CO 80205
Phone 303-384-3469 • Fax 303-322-7242

1-800-722-2800

www.leptron.com

Table of Contents

Table of Contents	1
Updating the Firmware	3
Establishing a Connection	4
Wi-Fi Connection	4
Ethernet Connection	4
Web Configuration Page Overview	5
Home Page	6
Live View Page	7
Capture	8
QR	8
Streaming	8
Exposure (Advanced)	9
Options	9
API	10
Coverage Page	10
Download KMZ	10
Pre-Flight Estimator	11
Coverage Estimator	12
Settings Page	16
Basic Configuration	17
Timer Mode	17
External Trigger Mode	18
Overlap Mode	19
Manual Exposure	19
Advanced Configuration	20
Audio Options	20
Format for RAW files	20
PPS Pin Usage	21
Pin Purpose	21
Input (default)	21
Top of Frame Output	21
Post Processing Required	21
Technical Information and Options	22

Pulse Polarity	22
Streaming Allowed	22
Enabled SD Card Output	22
Multi-Sensor Configuration	22
Ethernet Configuration	23
Configure the host computer	23
Configure the sensor's IP address (optional)	23
Magnetometer Calibration	24
Magnetic Heading Check	27
Magnetic Interference Check	28
File Storage	29
LED Signals	30
Sensor/DLS 2 LED Signals	30
DLS 1 LED Signals	31
MicaSense Sensor APIs	32
HTTP API	32
Serial API	32
API Documentation	32

Updating the Firmware

It is essential to keep the sensor firmware updated at all times. The firmware in the sensor can be easily updated following these steps:

Download the firmware from <https://atlas.micasense.com> (Atlas account required)

Copy the *.bin file to the root folder of any storage device (the storage device that came with the sensor is recommended).

With sensor powered OFF, insert the storage device into the sensor.

Provide a source of power to the sensor and power the sensor ON if it doesn't power on automatically.

Wait approximately 30-60 seconds. Do not disconnect the power or turn off the sensor.

The sensor should then boot up normally, and the LED status light will flash approximately once every 1.5 seconds.

Verify the software was updated by checking the "Settings" page on the sensor's web page. The firmware version number is shown at the bottom of the page.



Power down the sensor, remove the storage device and delete the bin file (otherwise each time you power up the sensor, it will reinstall the firmware).

Establishing a Connection

Any device (such as a computer, tablet, or smartphone) can be used to establish a connection with the sensor using Wi-Fi or Ethernet.

Wi-Fi Connection

When the sensor has been powered on and has finished initializing, it will broadcast a Wi-Fi signal (if the Wi-Fi adapter is attached). The SSID includes the sensor name and serial number. The serial number is printed on the rear of the sensor.

The password for this Wi-Fi access point is:

`micasense`

Once connected to the sensor's Wi-Fi, open any web browser and access the sensor's web page by typing in "192.168.10.254" in the address bar of the browser.

Ethernet Connection





It is possible to connect to the sensor via Ethernet. First, you will need a cable or adapter that connects an Ethernet cable to the appropriate port on the sensor (see your sensor's integration guide for details).

Manual TCP/IP configuration is required. Set the host computer's Ethernet to use a manual IP address in the block 192.168.1.0-255. We recommend the IP address 192.168.1.40 if it is not in use already. Set the host computer's subnet mask to 255.255.255.0.

Once the host computer's Ethernet has been configured, connect to the configuration page using the Ethernet IP address (192.168.1.83 by default). The IP address can be changed in Settings > Advanced > Ethernet Configuration.

Web Configuration Page Overview

There are 4 main “pages” for the sensor:

	Home Page
	Live View Page
	Coverage Page
	Settings Page

Home Page

Provides status information for the sensor and the GPS receiver that is connected to it.

The time is provided by a connected GPS device.

“Capture Config” shows the current automatic trigger setting (overlap, timer, external trigger, or disabled).



Live View Page

Provides a live preview of images captured with the sensor.

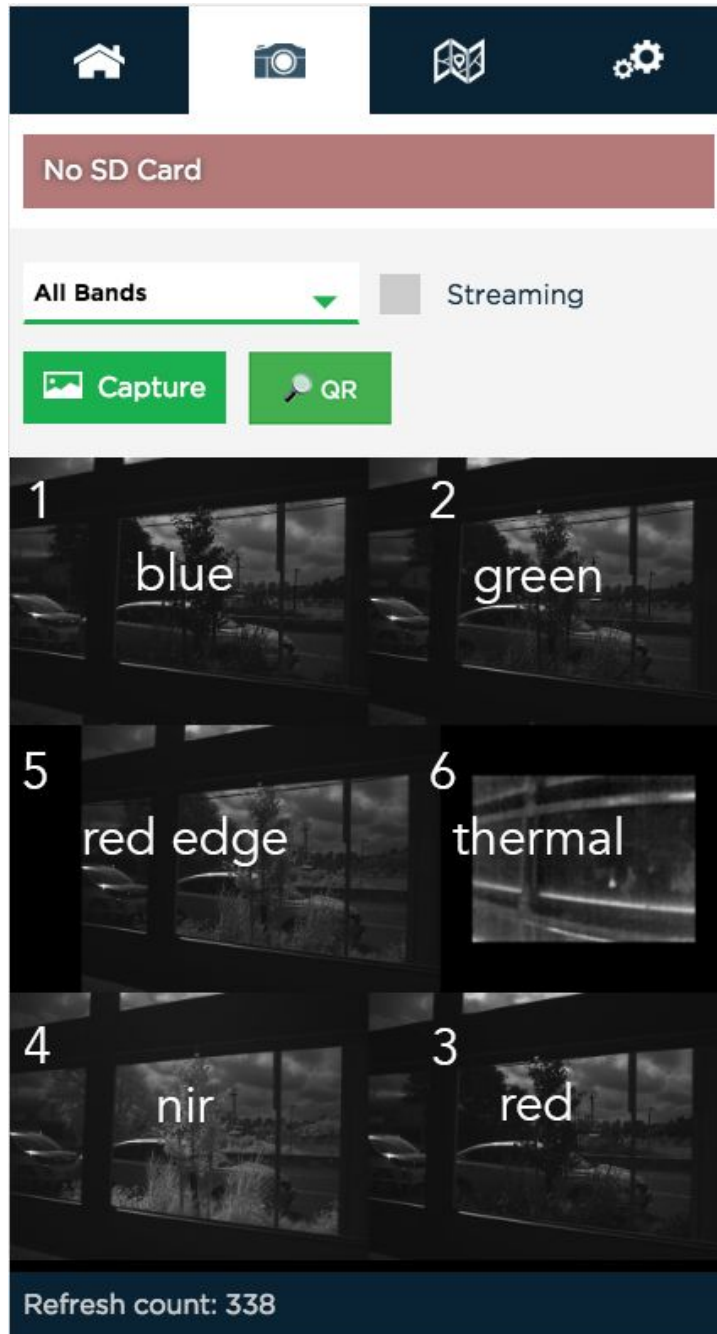

Whenever the sensor captures images manually (using either the physical button or the web button), the selected image(s) will be displayed in the Live View page based on the setting of the “Band” pull-down menu. Instead of displaying “All Bands” you can choose to display individual band numbers, which are notated in the image above. The total number of bands available for display depends on the sensor.

Capture

The capture button forces a capture for the sensor, and is equivalent to pressing the manual trigger button on the sensor.

QR

The QR button starts automatic panel detection mode. In this mode, the sensor displays a live preview, updated about twice every second. The configuration page and sensors with internal speakers will play a sound until the sensor detects a MicaSense reflectance panel and QR code. Once detected, the sensor will trigger a capture of the panel automatically and exit the mode. To exit the automatic panel detection mode, press the “Stop” button.

Streaming

The Streaming checkbox is used for near-real-time preview images from the sensor. When the Streaming mode is enabled, the images shown will update as quickly as the sensor can support it (approximately twice a second). The “Refresh count” shows how many times the display has been updated. Note that streaming mode does not save any images to the storage device. It just enables fast capture of the sensor for preview purposes only. Streaming mode works best when connected to the sensor via Ethernet.

NOTE

Streaming mode is intended for live-preview. Disable streaming mode before starting any other operations (particularly before enabling auto-capture mode or flying).

Exposure (Advanced)

If Manual Exposure has been enabled in the [Settings](#) page, exposure settings will appear at the top of the [Live View](#) page. There are exposure settings available for each band of the sensor. These settings will apply to each image the sensor takes until they are changed or disabled.

NOTE

This is an advanced operation option and should normally be disabled. By default, the sensor automatically adjusts gain and exposure.

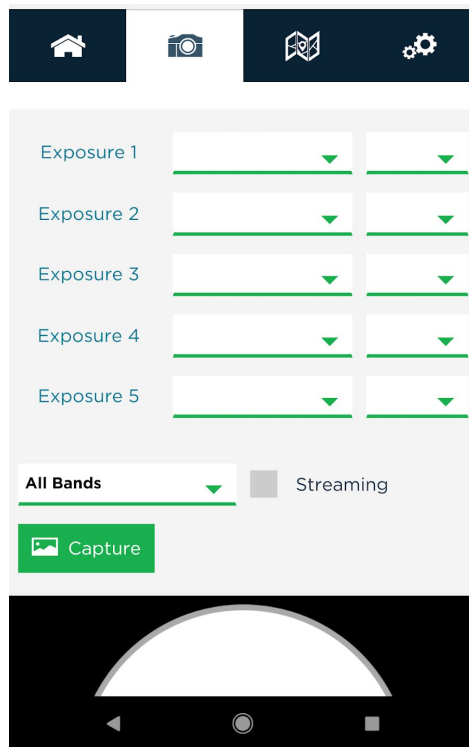

Options

The first option controls the length of exposure. It ranges from 0.066 ms to 24.5 ms and indicates the amount of time the global shutter is "open" and recording light.

The second option controls the gain, which indicates how much to amplify the incoming signal. The available values are 1x, 2x, 4x, and 8x. The original pixel values are multiplied by the chosen option.

API

These settings can be configured dynamically using the MicaSense API. See the exposure section of the API documentation for details: <http://www.micasense.com/api>

Coverage Page

The coverage page provides information on the geographic location where images in the storage device were captured based on the GPS module information. This page also provides a calculator for estimating parameters for mission planning.



Download KMZ

[captures.kmz](#)

Click the link above to download a KMZ file containing the locations of all captures currently stored on the SD card

Pre-Flight Estimator ▾

Coverage Estimator

Estimate the coverage area of selected flights.

Choose Flight(s) ▾

Select one or more flights:

Download KMZ

Clicking the “captures.kmz” link will cause the sensor to generate a KMZ file that will be downloaded by your browser. The KMZ file contains the lat/lon/alt of all captures in the storage

device and can be used to verify coverage after a flight or series of flights. The KMZ file can be opened using a GIS application (like QGIS or Google Earth)

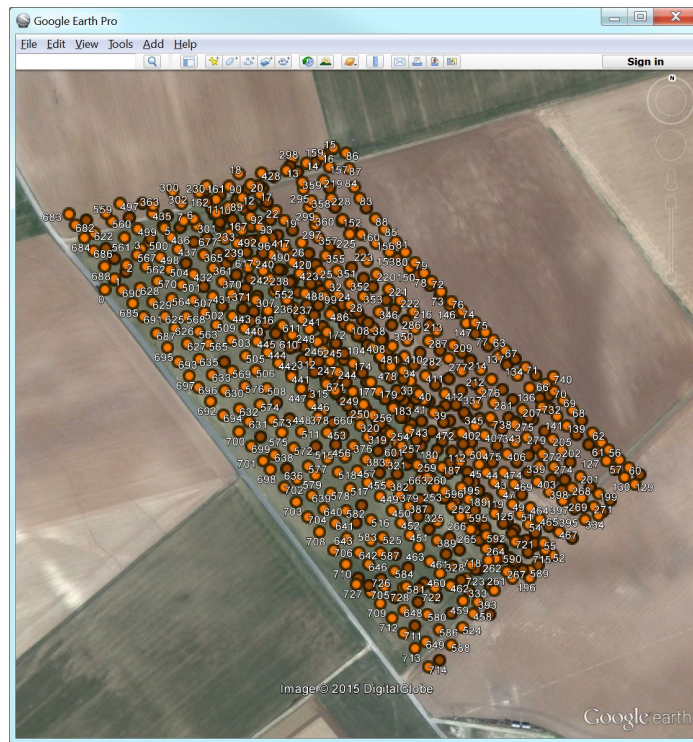

Pre-Flight Estimator

The Pre-flight Estimator is a calculator that can estimate the results of a flight mission. Enter the mission parameters and press the “calculate” button to see the results below.

Pre-Flight Estimator ^

Estimate the result of a flight mission.

Mission Input

Altitude AGL: m GSD: cm/px

Flight Speed: m/s Area of the Field: acre

Forward Overlap: % Cross Overlap: %

Camera Orientation: Image Output:

Aircraft Type:

Estimated Mission Result

Footprint Width: <input type="text" value="104.73"/> m	Footprint Height: <input type="text" value="78.55"/> m
Distance between Capture: <input type="text" value="19.64"/> m	Distance between Track: <input type="text" value="26.18"/> m
Time between Capture: 3.93 seconds	Flight Time: 0 hours 8 minutes
Number of Captures: 88	Number of Images: 440
Area per Hour: <input type="text" value="85.47"/> acre/hr	Storage Space Requirement: 1.08 GB

Coverage Estimator

The Coverage Estimator is a tool for quickly checking that a flight has sufficient overlap. From the initial Coverage Page, select one or more image sets to estimate and click "Next" (note: image sets must be geographically close together in order to work properly).

The Flight Adjustment tab should appear, and show a summary of its current estimation settings. Sensor Orientation indicates the directionality of the sensor with respect to the aircraft, as shown below.

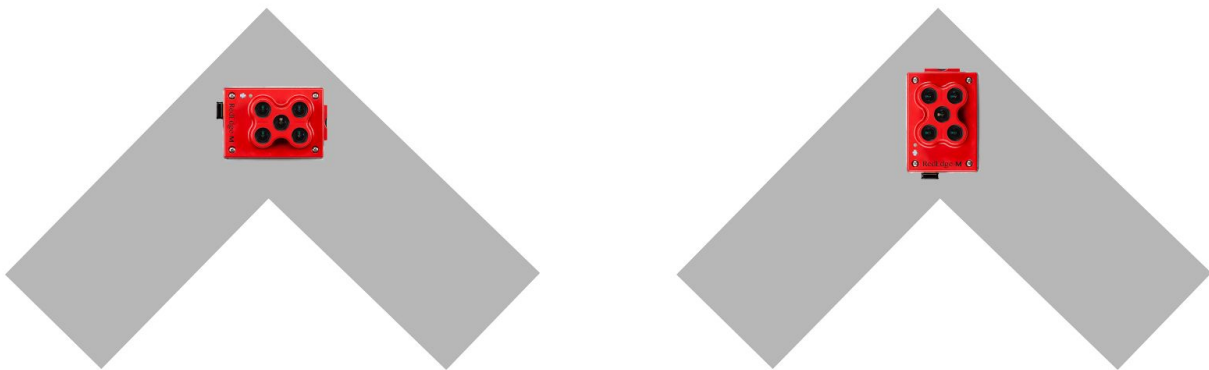

The Flight AGL is estimated based on the GPS positions recorded for the images, with the assumption that calibration panel pictures were taken near ground level, but if the estimate is incorrect, you can manually enter the correct AGL.

The Estimate Resolution sets the quality of the output map. Low is sufficient for most applications.

Choose Flight(s) ▾

Flight Adjustment ▾

Selected Flight

0001SET

Flight Data

Estimated AGL:	80.06 meters
Horizontal GSD:	12.01 cm / pixel

Setting

Camera Orientation:	Landscape ▾
Flight AGL:	80.06 <input type="text"/> meters
Estimate Resolution:	Low (faster) ▾

Draw Coverage

Clicking “Draw Coverage” will render the coverage estimate. The rendering time depends on your device’s CPU, the size of the field, number of images, flight AGL, and quality setting, but typically runs in under 30 seconds on a modern smartphone.

Finally, you will be presented with an estimate of your coverage. Any area that is dark green has a high probability of correctly being processed in Pix4D or other image processing platforms. Areas that are yellow may work, but likely will not. Red areas will almost certainly not process correctly. Edges around the field will typically show as red or yellow. This is okay as long as the data you are trying to collect is all contained within the dark green region.

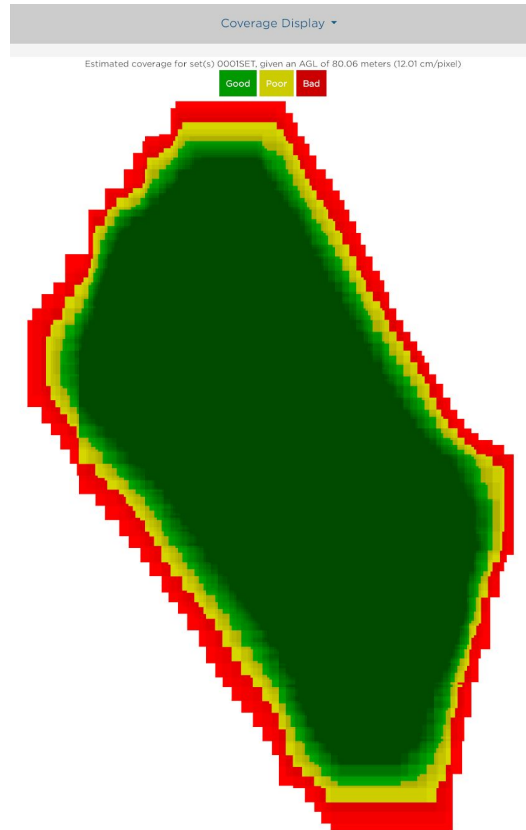

Example of good field coverage

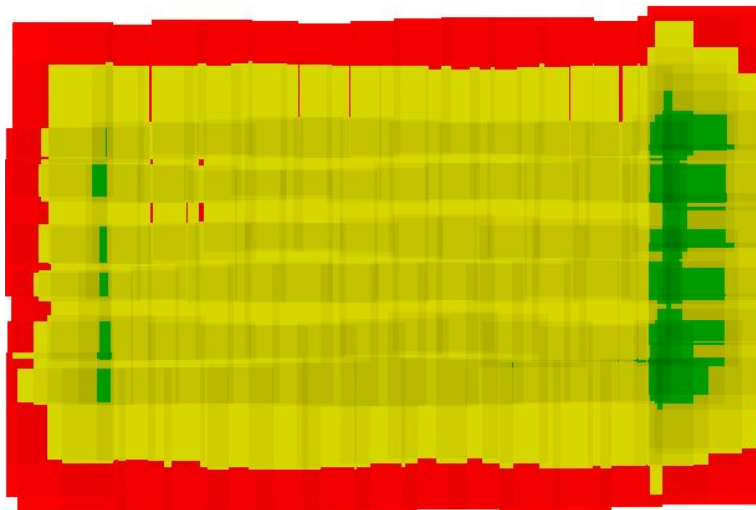

Example of poor field coverage

If you discover that your field coverage estimate is similar to the poor field coverage map shown above, double check to make sure the Flight AGL is set correctly. If the Flight AGL is incorrect, click back on the Flight Adjustment section, correct the Flight AGL, then click on "Draw Coverage" again. If the Flight AGL is correct, your overlap settings may have be wrong. You will need to capture more images of the field to ensure that post-processing will be successful.

The most common cause of incorrect overlap is that the sensor's parameters have not been entered into the flight planning software for use in calculating track distances. Check our knowledge base or your sensor's integration guide for sensor parameters that should be used in flight planning. You can also confirm that the track spacing is correct by checking it against the values given by the sensor's Pre-Flight Estimator tool ("Distance between capture" is the forward overlap distance and "Distance between track" is the side overlap distance).

Settings Page

The settings page is used primarily to configure the Auto-Capture options for the sensor. The sensor supports three methods of Auto-Capture: Timer mode, External Trigger mode, and Overlap mode.

Basic Configuration ^

Auto-Capture Mode: **Disabled**

Manual Exposure: Enable

Save

Advanced Configuration v

Software Version: v1.5.7 | Camera Serial: 15050002LT

Basic Configuration

Timer Mode

Use the drop-down menu to select Auto-Capture Mode as “Timer”

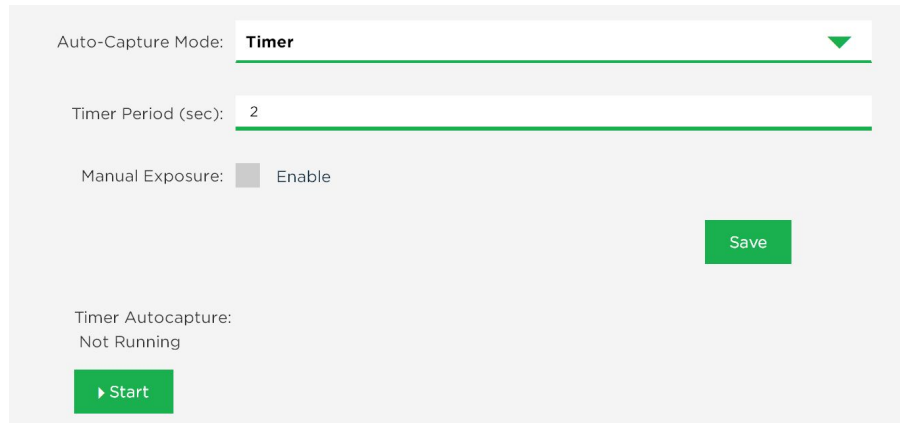

The screenshot shows a configuration window for Timer Mode. It features a drop-down menu for 'Auto-Capture Mode' set to 'Timer', a text input for 'Timer Period (sec)' set to '2', a checkbox for 'Manual Exposure' which is currently unchecked, and a 'Save' button. Below these, it indicates 'Timer Autocapture: Not Running' with a 'Start' button.

In the updated window, specify the “Timer Period (sec)” (the interval between pictures) to the desired setting. If the timer interval is set to less than 1.0 seconds, the sensor may not run at the specified interval, but will capture as quickly as it can (about once per second).

Press the “Save” button to save the Timer mode settings. Items that have been changed will be colored yellow until saved, at which point they will turn green.

Press the Start button to begin capturing images at the desired interval rate.

Press the Stop button to stop capturing images.

External Trigger Mode

For external trigger mode, you will need to connect a triggering signal to the sensor – refer to your sensor’s Integration Guide.

Use the drop-down menu to select Auto-Capture Mode as “Ext. Trigger”

The screenshot shows a configuration window with the following settings:

- Auto-Capture Mode: **Ext. Trigger** (dropdown menu)
- Ext Trigger Mode: **Short PWM** (dropdown menu)
- PWM Threshold (ms): **1.5** (text input field)
- Manual Exposure: Enable

A green **Save** button is positioned at the bottom right of the configuration area.

In the updated window, select the external trigger mode from the list. The settings are as follows:

Setting	Meaning
Rising Edge	Sensor will trigger on the rising edge of a pulse
Falling Edge	Sensor will trigger on the falling edge of a pulse
Short PWM	Sensor will trigger if PWM transitions from longer than Threshold to shorter than Threshold
Long PWM	Sensor will trigger if PWM transitions from shorter than Threshold to longer than Threshold

For PWM mode, enter the threshold PWM – note that this value is in milliseconds (ms), so the value is typically between 1.0 and 2.0.

Press the “Save” button to save the External Trigger mode settings.

Verify that the triggering is functioning by commanding a sensor capture through the host device.

Overlap Mode

Use the drop-down menu to select Auto-Capture Mode as “Overlap”

Auto-Capture Mode: **Overlap**

Target Alt: 100 meters (328.1 feet)

Along-Track Overlap: **80%**

Manual Exposure: Enable

Save

In the updated window, select the Target Alt to be the altitude AGL (Above Ground Level) at which the aircraft will be operating during the mapping mission. Note that this is specified as AGL altitude.

Specify the Along-Track Overlap as a percentage (%) of image that is common between one image and the next one.

Press the “Save” button to confirm the settings.

When the aircraft reaches the target altitude minus 50 meters, it will initiate taking captures. In overlap mode, it will only take a capture if the distance traveled is detected to be greater than the required distance at the specified target altitude as specified in the % overlap setting.

For example, if you set the target altitude to 120 meters, the sensor will start capturing when it reaches 70 meters altitude. When the measured altitude is lower than 70 meters (target altitude minus 50 meters), the sensor stops capturing.

Manual Exposure

The manual exposure checkbox enables manual control of the exposure and gain of the sensor, with settings available in the Live View Page. This is an advanced operation option and should normally NOT be enabled.

Advanced Configuration

The Advanced Configuration menu provides controls for managing file storage as well as Ethernet and Multi-Sensor configurations.

IMPORTANT

Make sure to click the "Save" button after making any changes, or the changes will be lost.

Home
Camera
Map
Settings

Basic Configuration ^

Advanced Configuration ^

Audio Options

Audio Enable: **Enabled**

Format for RAW files

DNG: **Smaller files, not compatible with all software**

TIFF: **Larger files, most compatible file format**

RAW format: **TIFF (16-bit)**

PPS Pin Usage

Select the purpose of pin 4 on H3 of a RedEdge, called GPS PPS in the RedEdge Integration Guide, or pin 3 on the Altum's host connector, called CAM PPS OUT in the Altum Integration Guide.

The default usage of this pin is as a PPS input (RedEdge) or PPS output (Altum). Top of Frame Output is for advanced integrators when external hardware, such as an RTK GPS receiver, needs to know the precise moment the RedEdge captures images.

⚠ WARNING: Enabling Top of Frame output on RedEdge changes the PPS pin purpose from a digital input to a digital output. Damage to the camera may occur if another output pin, such as the PPS output on a GPS receiver, is connected when Top of Frame Output mode is enabled.

Pin Purpose: **Input (default)**

Enabled SD Output files

Select type of file(s) to be saved to SD card for each band

Camera	Raw
1	<input checked="" type="checkbox"/>
2	<input checked="" type="checkbox"/>
3	<input checked="" type="checkbox"/>
4	<input checked="" type="checkbox"/>
5	<input checked="" type="checkbox"/>
6	<input checked="" type="checkbox"/>

Multi-Camera Configuration

Network Mode: **Master**

Multi-camera setups must have exactly one master

The camera must be rebooted for a mode change to take effect

Type	Mode	Serial	Software	GPS
Ethernet Configuration				
Select a static IP address that is not already used on your network				
The camera must be rebooted for an IP change to take effect				
IP Address:	192.168.1.81			
Save				

Storage and Firmware ^

Update Firmware
Reformat Storage

DLS Configuration ^

Calibrate DLS Mag

Regulatory Notices ^

Software Version: v1.3.5 | Camera Serial: AL03-18320R2-SC

Audio Options

On sensors that have internal speakers, users can enable or disable audio output. This applies to all sounds, including the start-up sound as well as the sound made during the “QR” or automatic panel detection mode.

Format for RAW files

You can specify the RAW Format to be either 12-bit TIFF (DNG) or 16-bit TIFF. The 12-bit DNG TIFF format will produce files that are 25% smaller in size than 16-bit TIFF files, but are not supported by some image software. Note that the sensor outputs 12-bit data, so storing the data as 12-bit DNG TIFF is lossless, whereas storing it as 16-bit TIFFs adds extra padding (but is still lossless).

PPS Pin Usage

You can specify how you wish to use the PPS pin on the sensor. PPS Pin Usage differs between RedEdge and Altum. For details about PPS pin usage and Top of Frame output, please visit the integration guide specific to your sensor model. For advanced integrations, this pin can be changed from a digital input to a digital output in the Advanced Configuration page.

Pin Purpose

Altum’s Pin 3 is an output. By default, it is a PPS output. For advanced integrations, this pin can be configured as a Top of Frame output instead, to signal to external devices the precise moment when the Altum captures images.

Input (default)

RedEdge GPS Pin 4 is, by default, a general-purpose input pin but can become an output pin as specified below.

Top of Frame Output

⚠ WARNING

Enabling Top of Frame output changes the PPS pin purpose from a digital input to a digital output.

Damage to the sensor may occur if another output pin, such as the PPS output on a GPS receiver, is connected when Top of Frame Output mode is enabled.

If you are using the provided GPS, please disconnect it entirely or at least unplug the wire going to the PPS pin before enabling top-of-frame output.

This is for advanced integrations only, when external hardware, such as an RTK GPS receiver, needs to know the precise moment the sensor captures images. It is available in firmware version 1.5.28 and higher.

Post Processing Required

If you use top-of-frame output with an RTK GPS device, you will have to update the metadata of the images with the RTK GPS information in post processing; the sensor does not write this information into the image metadata. As a backup, it is a good idea to send constant GPS information to the sensor during flight using the Serial or HTTP APIs (<https://www.micasense.com/api>), which the sensor will write into the image metadata.

Technical Information and Options

The Top of Frame output is a 3.0 V, 100 ms pulse, with the leading edge indicating the beginning of the exposures. The output should be considered an open-drain output (though it has an edge-accelerator in both directions). Large capacitive loads can cause the edge-accelerator to be triggered multiple times as the signal rises and falls which may cause double triggering. The output is coupled to the connector pin through a 100 ohm resistor and has around 25 pF of capacitance to the pin.

Pulse Polarity

“Pulse high, rest low”: The pin will output 0 V until a capture is taken, then it will output a 3 V signal for 100 ms.

“Pulse low, rest high”: The pin will output 3 V until a capture is taken, then it will output 0 V for 100 ms.

Streaming Allowed

When enabled, if the sensor is in streaming mode, a top-of-frame output signal will be sent each time the image updates (about once per second), even though the images shown in streaming mode are not saved to the storage device.

Enabled SD Card Output

This menu enables the user to specify which bands to write to the SD card. The default of capturing all bands is the recommended setting. However, if only a subset of the bands are desired, the other bands can be deselected. Click the “Save” button to commit any changes.

Multi-Sensor Configuration

The Network Mode is only relevant if you have more than one sensor and wish to capture simultaneously. The table will list the settings of all other networked sensors. In addition to configuring a single master, all of the sensor software versions should match. After changing the sensor's network mode, you must click "Save", and then reboot the sensor in order for the new setting to take effect.

Ethernet Configuration

Here, you can assign a different Ethernet IP address to the sensor. To use the Ethernet, you will need to obtain or build an adapter that connects to the appropriate port on the sensor (see your sensor's integration guide or the MicaSense knowledge base for details).

NOTE

The Ethernet IP address is 192.168.1.83 by default. Changing this setting does not update the Wi-Fi address, which will always be 192.168.10.254.

Configure the host computer

Set the host computer Ethernet to use a manual IP address in the block 192.168.1.0-255. We recommend the IP address 192.168.1.40 if it is not in use already. Set the host computer's subnet mask to 255.255.255.0.

Once you have configured your host computer's Ethernet, you can connect to the configuration page using the IP address you have set up.

Configure the sensor's IP address (optional)

The Ethernet IP address is 192.168.1.83 by default. If you would like to change this, you may need to connect via Wi-Fi. Enter the desired IP address (must be on the same subnet as the host computer) and press Save. The sensor must be rebooted for an IP change to take effect.

Storage and Firmware

Update Firmware

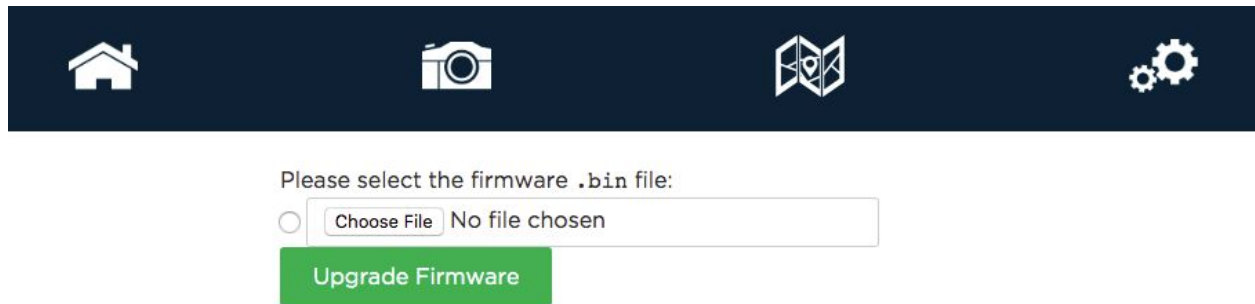

This section displays a list of all *.bin files on the attached USB drive. Use the radio button to select the .bin file you wish to use to upgrade. Alternatively, click the "Choose File" or "Browse" button to select a different file on your computer. Once the file of choice is selected, click the "Update Firmware" button to begin the update process. Do not disconnect the power or turn off the sensor until the process has completed.

Format Storage

Press the "Format Storage" button to erase all data on the attached storage device and reformat the device to a compatible format type. A warning will appear for confirmation.

Press "OK" to format and erase all data on the storage device or "Cancel" to keep all information on the disk

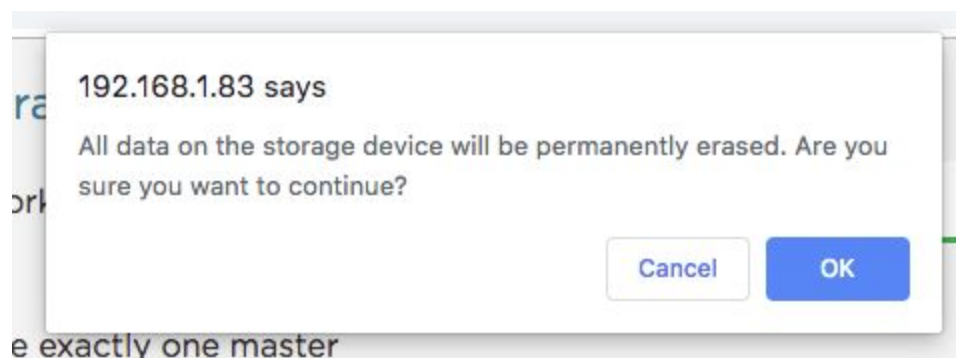

Magnetometer Calibration

This procedure is for the provided GPS only and is not required for configurations that provide GPS and attitude information via the serial or Ethernet connection. If the configuration for your sensor is one that uses the provided module for GPS and magnetometer data, a calibration process for the magnetometer is needed.

NOTE

You will need a compass to verify the calibration once completed.

From the Settings page, access the DLS Configuration section.

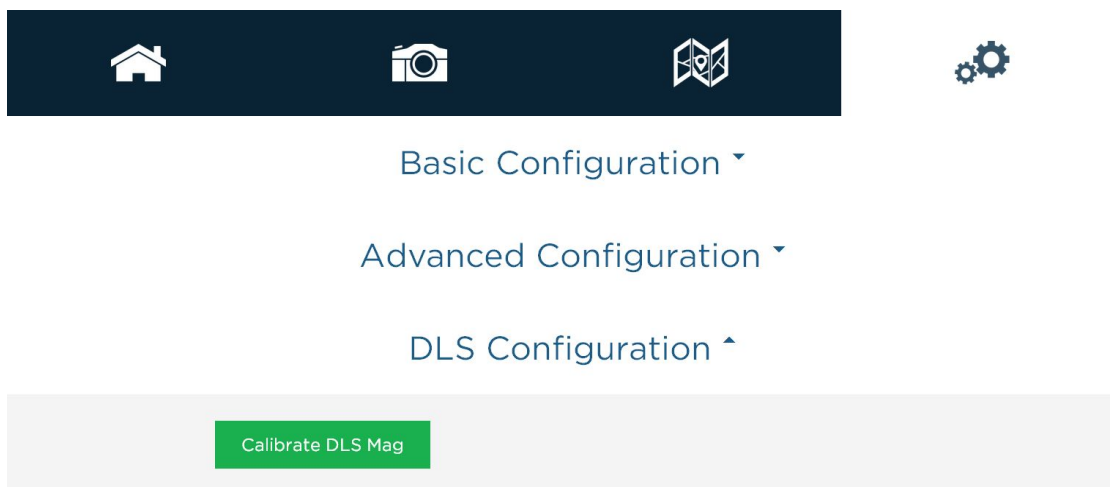

“Calibrate DLS Mag” is a clickable button that will start the calibration process. This calibration process is for the magnetometer sensor that is inside the 3DR GPS module.

Ensure that the DLS is connected to the GPS module with both the 4-pin and 6-pin connectors. Additionally, your DLS and GPS module should be rigidly mounted to your aircraft frame.

NOTE

Before beginning the calibration routine, position yourself and the drone away from large metal objects such as cars and buildings. Also avoid paved areas, which may have metal rods inside the cement. An open field is preferred to avoid interaction with any sources of magnetic interference or objects that may perturb the Earth's natural magnetic field.

Once the startup sequence has finished, you will be guided through the orientations your drone should be in for each of the calibration steps.

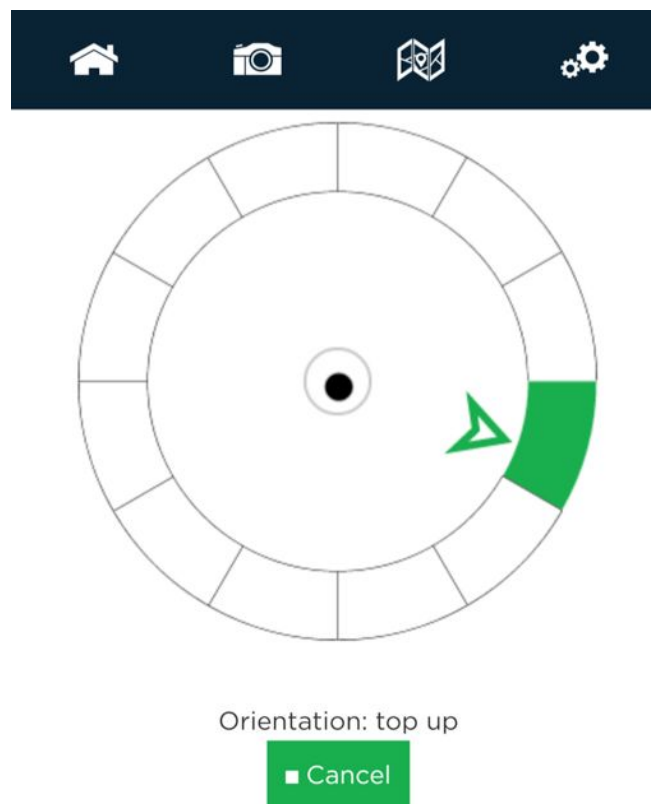

To calibrate the magnetometer, a 6-axis calibration routine needs to be performed. During the routine, the drone (specifically the GPS module) should remain in a fixed position while being rotated, i.e. the user performing the calibration should be moving around the magnetometer. The drone and GPS module should also be kept level to the plane they are on in each position. The on-screen rotation guide will show you when you have successfully completed one orientation and can move on to the next.

NOTE

The black dot is a level (like a bubble level), indicating how level the unit is compared to the plane it is on. It does not indicate how far away from the center of rotation the unit is.







NOTE

If you are using a Serial or HTTP connection to supply GPS and attitude information to the sensor, you do not need to perform the magnetometer calibration described above.

Magnetic Heading Check

Once the calibration routine has been completed, it is important to verify that the magnetometer information displayed in the Heading section of the sensor's Home Page is accurate.

A handheld compass has been provided with your kit that will allow you to verify this in the field. Access the sensor's Home Page and use the "Heading" field to check the four cardinal directions (North, East, South, West) and ensure a good match between the compass and the reading by the sensor. You should see an error of less than +/- 5 degrees. If this error is exceeded, redo the magnetometer calibration.

	   
Storage	✓ 29.5 of 29.7 GB Free
Sats	✓ 4 Used / 17 Visible
Time	2016-12-14 00:17:32 UTC
Location	47.64812, -122.34251
Altitude	3.5m MSL / -4.2m AGL
Speed	0.09m/s
Heading	267.6° (magnetic)

Additionally, you will want to perform a magnetic interference test to verify that your drone will not affect the heading readings during flight.

Magnetic Interference Check

A test procedure should be conducted any time electrical equipment is added or removed from the drone to ensure the magnetic field profile of the aircraft has not changed.

To test for any magnetic interference from the drone that is affecting the magnetometer, start by placing your drone facing North (you can use the magnetic heading from the Wi-Fi page to align yourself).

⚠ WARNING

The next section involves spinning up the motors of your drone.

If you have a fixed wing aircraft this will require holding the aircraft in place while keeping clear of the propeller.

If using a multi-rotor, setup the aircraft as if it was ready for a normal take off, but you do not need to actually take off, just spin up of motors.

You DO NOT need to provide full power to the motor(s).

Throttle up the motor(s) on your drone and ensure that the heading reading has not changed, then throttle back down. Repeat this for each direction (North, East, South, West) to ensure there is no magnetic interference in any of the four cardinal directions.

⚠ WARNING

FAILURE TO FOLLOW INSTRUCTIONS TO KEEP CLEAR OF SPINNING BLADES COULD RESULT IN INJURY OR DEATH.

NOTE

Electromagnetic interference during the operation of your drone can cause errors in the magnetic heading readings. This can cause the irradiance data generated by the DLS to be not usable during processing.

File Storage

The sensor stores files in the storage device in a folder structure. A new folder is created for each time the sensor is powered up. For example: "0000SET", "0001SET", ...

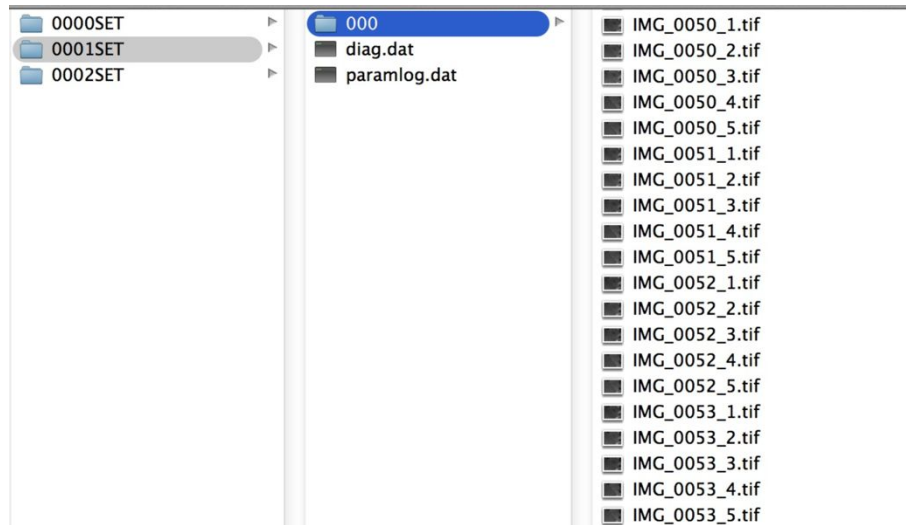

Within each folder, a subfolder with the images themselves is created. If more than 200 images are stored, a second image folder is created ("000" and "001" for instance). Two log files are also created for each sensor power cycle (diag.dat and paramlog.dat). The log files are proprietary and can only be read by MicaSense.

Within each subfolder, a group of TIFF files is created for each image capture. The suffix at the end of each file indicates the imager number. Please see your sensor's integration guide for details.

The TIFF files are 12-bit resolution stored in either 12-bit DNG TIFF RAW format or 16-bit TIFF RAW format depending on the setting (see Settings > Advanced). Metadata tags are embedded for each file in standard EXIF format.

Sensor	12-Bit DNG	16-Bit TIFF	Files per capture	Resolution
Altum (MS)	4.78 MB	6.4 MB	5	2064 x 1544
Altum (Thermal)	45 KB	45 KB	1	160 x 120
RedEdge	1.8 MB	2.5 MB	5	1280 x 960

LED Signals

Sensor/DLS 2 LED Signals

One flash indicates normal behavior, that the sensor is operating as expected. More than one flash indicates an issue as outlined in the following table:

Color	Type	Meaning
Green	1 Flash	Sensor is ready for operation (it has a GPS fix and more than 2 GB available on the storage device)
Blue	1 Flash	Capture completed
Yellow	2 Flashes	GPS unit detected, but does not have a fix
Red	3 Flashes	GPS timeout
Red	4 Flashes	No storage device is installed
Red	5 Flashes	The storage device is full (or almost full)

DLS 2 LED Signals

The DLS 2 LED mimics the attached camera's LED signals, except during initial start-up. When powered on, the DLS 2 LED cycles through all of the colors for a "rainbow" effect, indicating that the DLS 2 is calibrating and needs to be motionless. Aircraft vibration and other subtle movement could cause the DLS 2 to stay in calibration mode until the motion stops.

DLS 1 LED Signals

There are two green LED lights on the DLS 1, one on either side of the unit. The meaning of the LEDs is as shown in the table below. The LEDs are small and may not be easy to see without getting close to the unit. Refer to the following table for signal meanings:

DLS LED Signal Type	Meaning
---------------------	---------

4 simultaneous flashes on both LEDs	This occurs upon boot-up of the DLS
Sporadic flashing	Communications received. This is normal behavior
Alternating blinking between the two LEDs	Indicates a software/hardware problem. If the problem persists, contact MicaSense at support@micasense.com
Both LEDs solid ON	

CAUTION

Power OFF the sensor before removing the storage device. Failure to do so may corrupt some of the files in the storage device if they are still being written.

MicaSense Sensor APIs

Using the API, users can communicate with the sensor programmatically via an HTTP or Serial connection.

HTTP API

The HTTP API is the most powerful way to interface with the sensor. You can use this API using either an Ethernet connector or the Wi-Fi access point.

Serial API

The Serial API provides a MAVLink interface to the sensor. You can use this API by connecting your MAVLink-capable system to the serial connections on the sensor. See the Integration Guide for your sensor to determine where to connect.

API Documentation

For the latest API documentation, including example code, please visit:

<https://www.micasense.com/api>

User Guide for MicaSense Sensors

Revision 07, June 2019

MicaSense, Inc.

Seattle WA 98103

-
- The contents of this guide are subject to change without notice
 - MicaSense, Inc. assumes no liability for incidental or consequential damages arising from the use of this product, and any claims by a third party.
 - Copying of the contents of this guide, in whole or in part is prohibited under the copyright law.